

SPORTS VENUE PADDING INC



Baseball



Sports Venue Padding is a company with over 50 years of experience in the sports protective padding industry. We are not just about sports. We are about player safety, and we never compromise on aesthetics or quality. We offer the industry's broadest range of best-in-class products, which include in-house design, engineering, and factory-trained installation teams, unmatched customer service, and a promise of complete satisfaction.

If you're watching a professional sports game, there's a good chance you're seeing our padding protecting players in high-impact areas throughout indoor and outdoor sports facilities. We fit sports padding to the unique characteristics of facility walls, fences, rails, posts, columns, gates, and other contact areas. Why do customers keep coming back? Because we take on unique construction challenges that our competition won't touch. Just ask any of the professional ball clubs, universities, or municipalities we've worked with.

Our background in the development of innovative padding solutions and team/sponsorship advertising makes us an asset to your team! Integrated digital printing provides a brilliant, oversized, clear image of your logo or sponsor ad that stands out and has extreme durability. None of the chipping or peeling that is common with applied decals.

As a Technical Expert Advisor to ASTM (American Society of Testing Materials), we help define what materials and foam densities best serve an athlete making contact with sports padding while on the move.

Let us show you the Sports Venue Padding difference.



CATALOG CONTENTS

STADIUM FIELD PADDING	4 - 5
SPONSOR ADVERTISING	6 - 7
RAIL PADDING	8 - 9
CUSTOM GATE PADDING	10 -11
BASELINE PADDING	12
BULLPEN PADDING	13
CUSTOM PADDING	14 - 15
INSTALLATION SERVICES	16

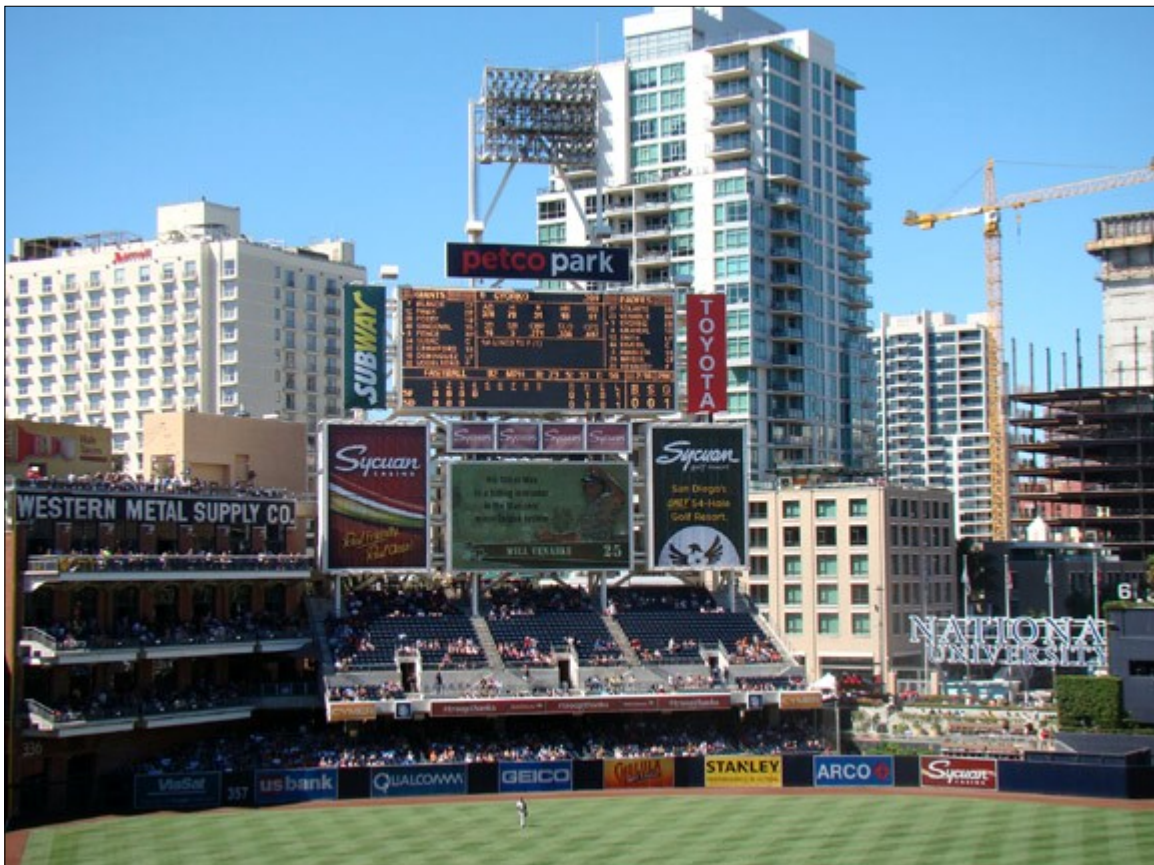

Stadium Field Padding

The key to impact protection for the athlete on the move! Several options are available:

- Available in 3", 4", 5" and 6" thickness to support the amount of protection required based on field design
- Foam filler densities specifically designed to ensure correct deceleration upon impact based on projected speed prior to impact
- UV-protected heavyweight vinyl cover designed to provide protection from fading and early wear. Comes with a five year manufacturer's warranty
- Vinyl is optimized for state-of-the-art digital printing of logos and sponsor advertising
- Durable backer board designed for long-term durability under all weather conditions, environmentally conscious materials
- Multiple secure surface attachment systems to fit any wall or fence design
- Field padding is designed to incorporate **"One Piece Construction"** wherever possible to promote a seamless appearance, greater **"Live Area for Digital Printing"** and to allow for ease of recovering when updating graphics or advertising
- Integrated home run lines

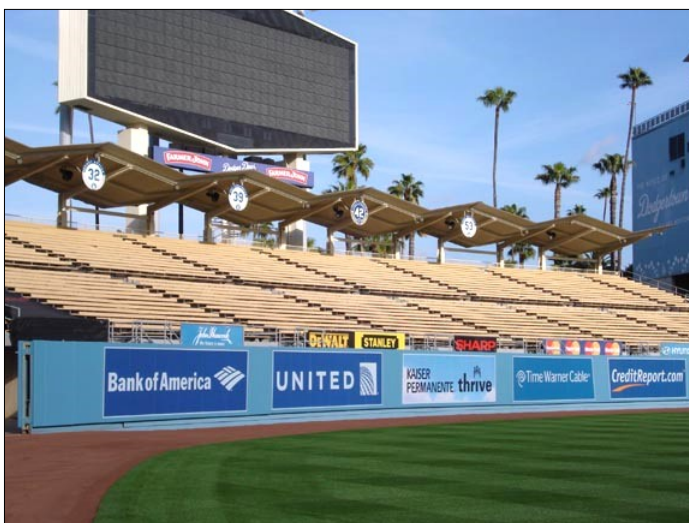

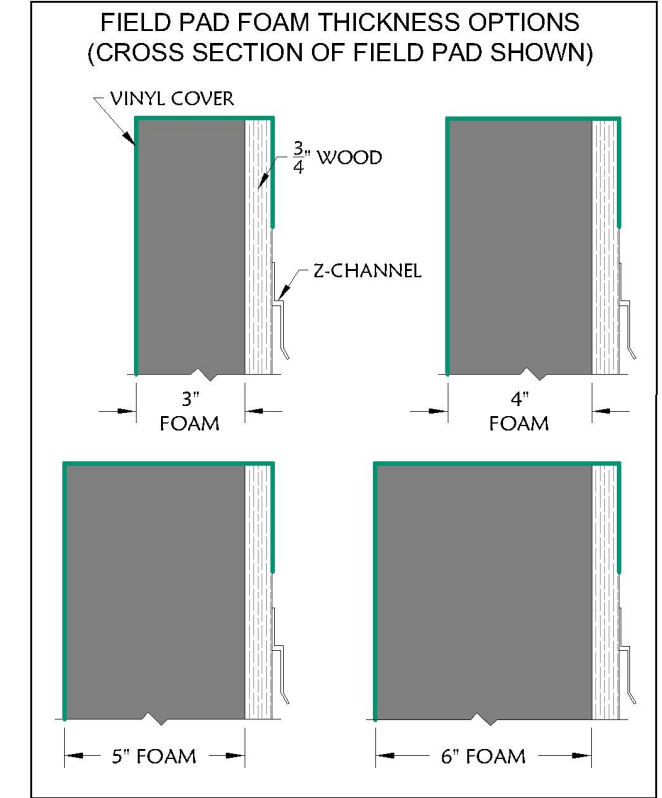

Sponsor Advertising

The process of applying Integrated Digital Printing of logos or sponsor advertising is different from anything you have experienced before. No decals or paint to chip, peel, or tear during the season.

- Durable UV Inks are applied directly to your vinyl color to create a beautiful billboard on field walls or rails
- Pads can be re-wrapped if graphics need to be changed or updated
- Complimentary graphic layout for your approval of artwork and field position



Here's how simple the process can be for you...

- **Step 1** - A complete field layout created for your approval by our in-house art/design team displaying all your team/sponsor signage
- **Step 2** - An individual layout of team/sponsor signage with dimensions created for your approval by our in-house art/design team prior to production
- **Step 3** - Production of new wall pads or replacement vinyl covers with the approved signage for installation as per the completed field layout

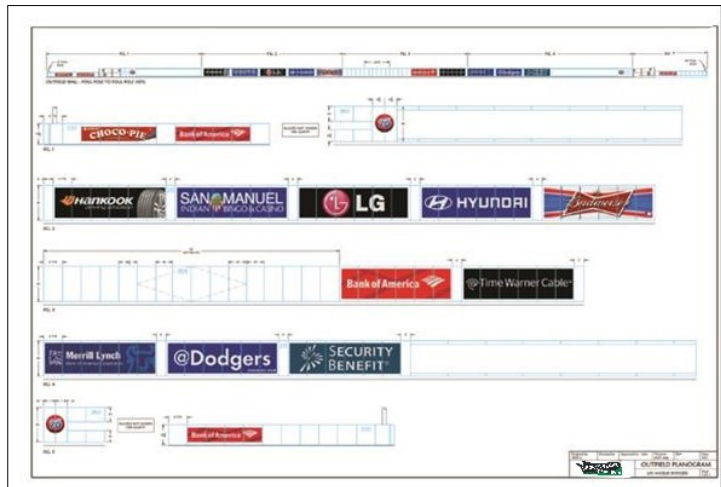



NOTES:	Colors (PMS, RGB, CMYK)		Location	Date
	Background 16, 100, 100.8		Outfield 1ft	Install Date
	Artwork 15% grey		Approval req'd by	Filename
	Vinyl SD Blue		Sponsor	SDTOY514

Prepared for:
New York Mets
Downtown

Date:

P.O.#:

Description:
Stub Hub graphic

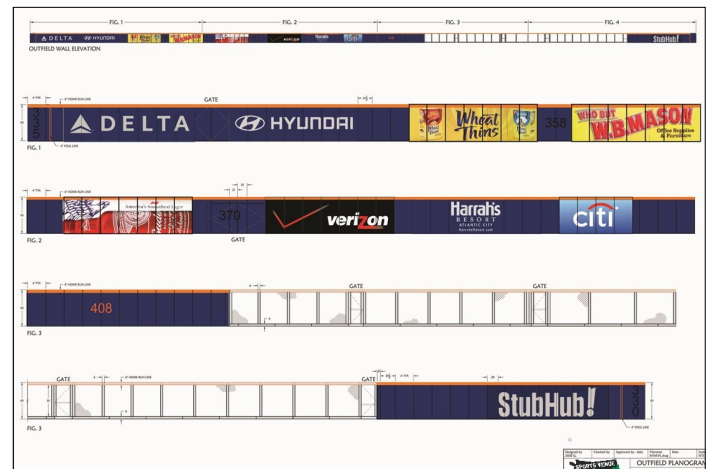
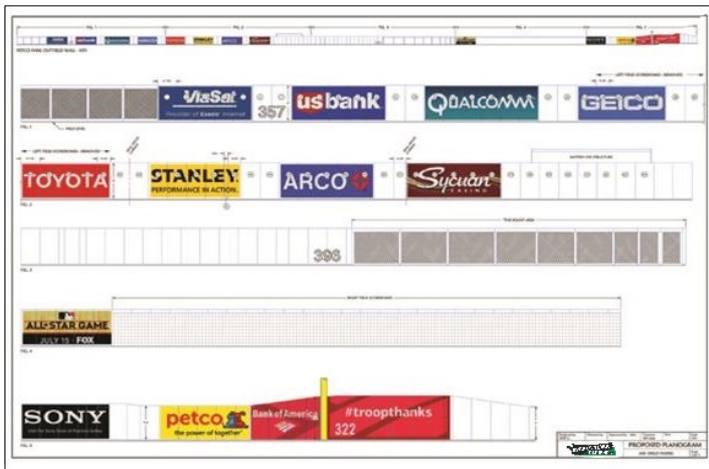

Uni-Rail Padding

Offers great protection for the players. Can be used for dug-outs, baselines, and fence top padding.

- Easy to install, closed-cell polyethylene high-impact foam can be hand cut in the field to fit the unique features of your railing
- Seamless vinyl top cover is available with or without Integrated Digital Printing and is installed over the foam. Cover comes with grommets evenly spaced for installation with industrial-strength cable ties or rope
- Easy to remove and replace at your convenience
- Beautiful, seamless presentation is both smooth and tight
- Durable and affordable
- Available for 1 1/4" to 2 3/4" rails
- For alternate rail sizes., please ask us about other available options

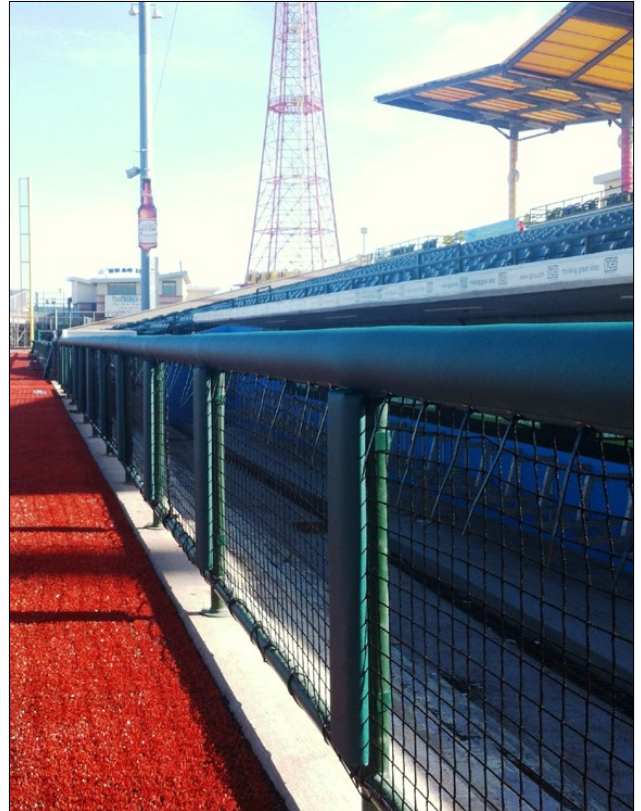
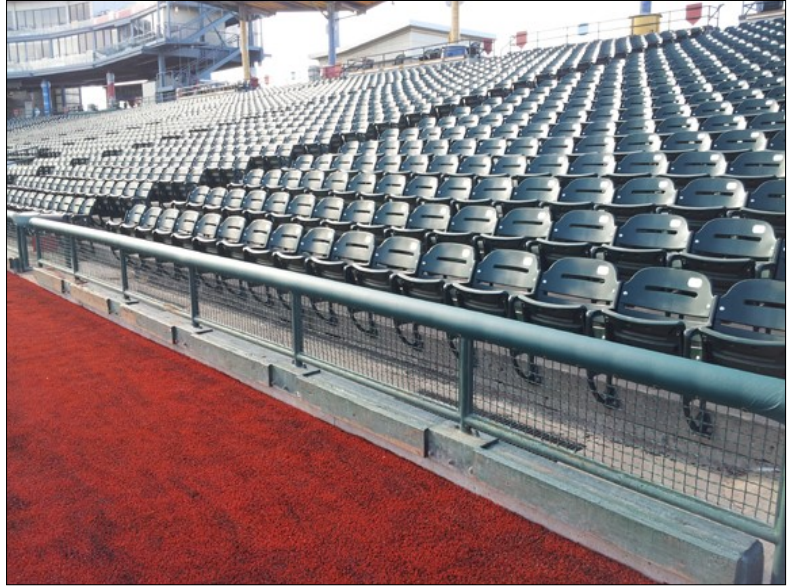

Perma-Rail Padding (Patent Pending)

The most innovative development in **Dug-Out Rail Padding** is now available! This advancement includes the following unique advantages

- Aluminum understructure designed to be a permanent fixture in your dug-out
- Features a solid locking system to deter rotation when leaned on by players
- Closed cell polyethylene high-impact padding protection will not absorb water or sag over time
- Solid seamless top cover features large, 6" front face for team logo and/or sponsor advertising. The cover can be replaced as often as you like. Easy to remove and re-install a new cover
- Fits 1.5" to 3" dug-out rail

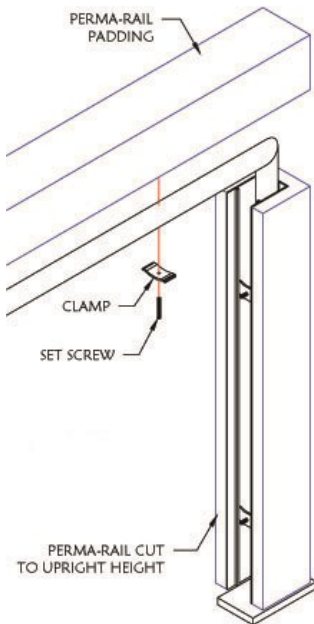

PATENT PENDING

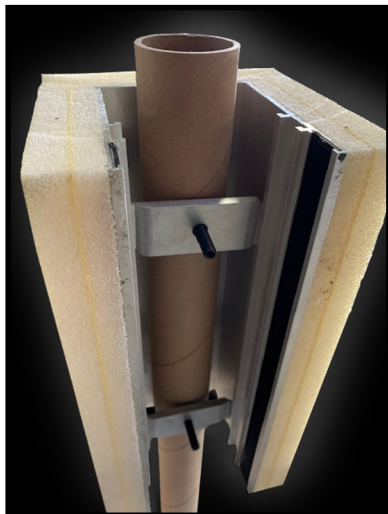

Sliding Gate Pad

A creative field-level solution to conceal hinges on any wall with gates that swing into the field of play

- Great for installation on baseline or short walls where you normally see a break in the wall padding, exposing the hinges
- Provides seamless look so gate locations are all the same height as aligning pads and all hinges are covered
- Slides glide easily to allow a full range of motion for a full 90° opening
- Designed for all gates that swing into the field of play
- Provides uninterrupted appearance and can include integrated digital printing. You can easily put graphics across the hinge area
- Specially designed commercial slides for all weather conditions



**Automatic Wedge Field Gate Pad
(Patent Pending)**

Sports Venue Padding now offers a gate pad that provides safety, convenience, and the ability to present continuous graphics in all gated areas of your stadium. Available in any size with or without graphics

- Designed for all gates that swing into the field of play
- Wedge pad covers and protects exposed hinges that can cause injury to the players
- Automatic hinged feature eliminates the need to manually remove vinyl cover or sewn wedge pads, attached with Velcro
- The hinged pad returns to closed position automatically when the gate is closed
- Provides seamless appearance and can include integrated digital printing. You can easily put graphics across the hinge area



PATENT PENDING





BASELINE PADDING

Baseline Padding

Baselines vary in height and typically have objects along the way that require specialized padding to cover. Our padding is built to accommodate and fit over all exposed areas for maximum protection.

- Available in 3", 4", 5" and 6" thicknesses to support the amount of protection required based on field design
- Foam filler densities specifically designed to ensure correct deceleration upon impact based on projected speed before impact
- UV-protected heavyweight vinyl cover designed to provide protection from fading and early wear. Comes with a five-year manufacturer's warranty
- Vinyl is optimized for state-of-the-art digital printing of logos and sponsor advertising
- Durable backer board designed for long-term durability under all weather conditions. Environmentally conscious materials
- Multiple secure surface attachment systems to fit any wall or fence design
- Baseline padding is designed to incorporate **"One Piece Construction"** wherever possible to promote a seamless appearance, greater **"Live Area for Digital Printing"** and to allow for ease of recovering

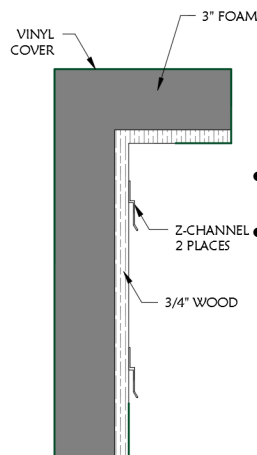
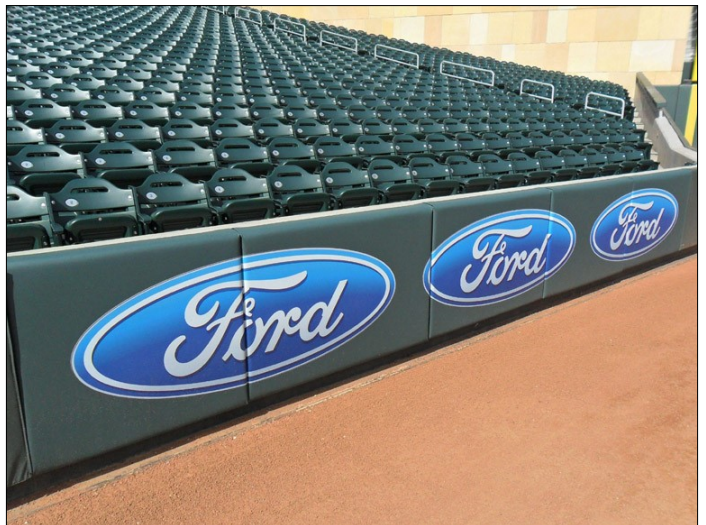

- One piece construction
- Easy to recover as needed

www.SportsVenuePadding.com

P: 562.926.0835 T: 877.599.6855 E: info@svpadding.com



BULLPEN PADDING

Bullpen Padding

When it comes to Bullpens, they all are different and require special sizes and shapes of padding to provide the right protection without affecting a view of the field.

- Available in multiple thicknesses with our recommendation for foam filler density, UV protected heavyweight vinyl cover with five year manufacturer's warranty, and durable backer board designed for long-term durability under all weather conditions
- Vinyl is optimized for state-of-the-art digital printing of logos and sponsor advertising if desired
- Multiple secure surface attachment systems to fit any walls, fences, or gates
- Bullpen padding is designed to incorporate **"One Piece Construction"** wherever possible to promote a seamless appearance, greater **"Live Area for Digital Printing"** and to allow for ease of recovering as needed
- Wood-backed bullpen padding allows for a cleaner appearance and ease of recovering over sewn pads while providing equivalent protection for the players

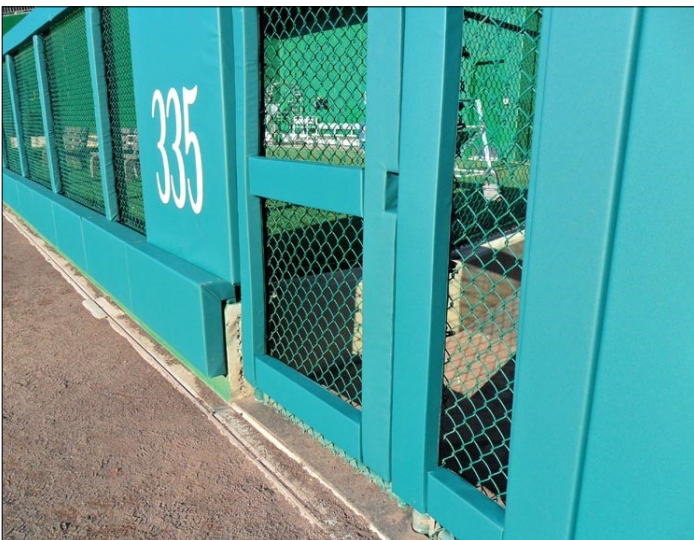

www.SportsVenuePadding.com

P: 562.926.0835 T: 877.599.6855 E: info@svpadding.com

Custom Padding

Every facility has areas that require special padding to cover doors, gates, electrical boxes, camera wells, concrete curbs, vertical posts, special seating areas rotational, and more

- Field wall and surface irregularities require the development of special padded boxes, L-Shaped padding, round-shaped padding, or cut-outs to cover exposed areas
- Field-level rotational signage or padding for scoreboards is built to size
- Replacement seat padding built to fit your specific seat design
- Seat Back Slip Covers to promote your team logo or sponsor advertising
- Sectional Weather Protection Covers to protect your seats during harsh weather conditions
- Mesh section covers to close off unused areas, allowing them to become great advertising vehicles
- Bench Padding for dug-outs
- Plate, mound, or turf covers
- Batter's eye screen
- Scoreboard top padding



Multiple Custom Solutions



Padded Rotational Sign

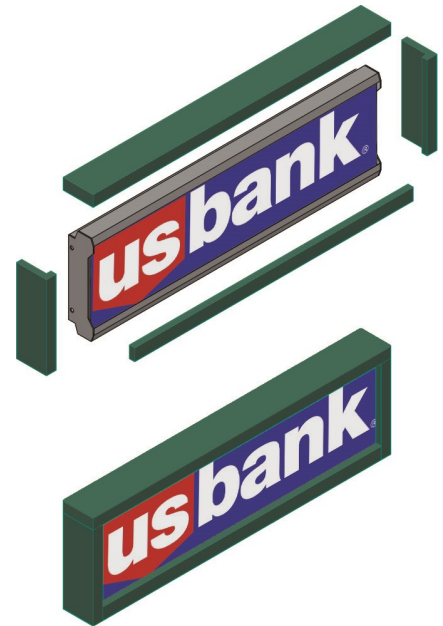



Seat back covers and seat padding



Dug Out Camera Padding



Section covers with storage solution



Padded handicap Lift Gate Pad



Batters Eye



Padded camera well



Installation Services —————

Several options are available for the installation of sports padding:

- **Field Measure** - Prior to the installation, our skilled team will perform a thorough field visit to identify the specific needs of our field.
- **Factory Trained Installation Team** - We send our factory trained team to your facility for a complete turnkey installation.
- **Factory Project Manager** - Our factory project manager travels to your facility and trains your staff to perform the installation.
- **Factory Instructions** - Your staff installs padding produces using factory installation instructions.

OSHA 10 & 30 Hour compliant project management for your project.

Sports Venue Padding, Inc.

P: 562.926.0835 T: 877.599.6855

E: info@svpadding.com

www.SportsVenuePadding.com