

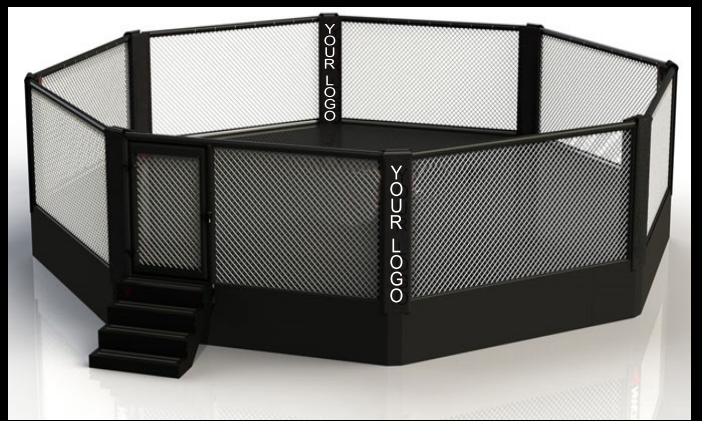

# RECREATION



**Wall Padding • Mats • Windscreens**  
**Skill Development • Banners**



**SPORTS VENUE PADDING** is an experienced manufacturer of sports padding, padding solutions for difficult to cover areas, outdoor and indoor wall padding, post/column/I-Beam padding, fence windscreen, mixed martial arts padding, fitness and gymnasium exercise mats, folding mats and landing mats, early childhood skill development shapes, early learning products, banners, and digitally printed graphics available on all sports products.

With engineered design and automated systems behind the fabrication of our products, our core focus is on protection, safety, and learning. We actively serve on several committees at ASTM (American Society of Testing Materials) to help develop international manufacturing standards for sports padding products.

Large-format **Integrated Digital Printing** allows our clients to place brand logos, team names, and/or learning programs directly onto the surface of our products. Installation is available nationwide! We welcome your questions, and we hope to earn your business!

## CATALOG CONTENTS

3	Indoor Wall Padding	11	Exercise and Folding Mats
4	Corners/Cut-outs/Custom Pads	12	Landing and Climbing Wall Mats
5	Columns and I-Beams	13	Skill Development
6	Backstop Padding	17	Early Learning
7	Outdoor Field Padding	18	Banners
8	Fence and Tennis Windscreen	19	Maintenance/Repair Supplies
9	Post Pads	20	Installation Services
10	Mixed Martial Arts		

### INDOOR WALL PADDING

- Indoor wall padding is available up to 8 ft. high and is produced in 2 ft. wide panels.
- Available in many filler densities, thicknesses, and combinations to meet all safety requirements.
- Covers are made with an 18 oz. coated vinyl.
- Durable backer board for attachment to walls.
- Cut-outs for outlets, fire extinguishers, thermostats, 2 and 3-sided columns, drinking fountains, indoor bleachers, and any other wall features in your facility.
- Wall padding options include meeting E84-NFP 101/255 fire-lifestyle safety regulations.
- Team logos, sponsor advertising, or special messages can be **digitally printed** directly onto colored vinyl with our in-house **integrated print system**.
- Complimentary design layouts let you choose the look you want.



**Graphics  
Printed In-House**

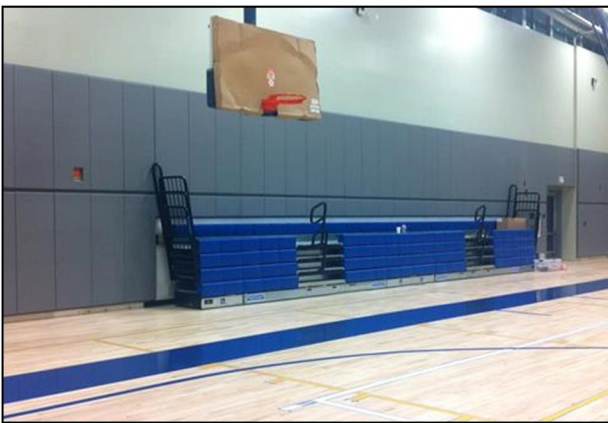

All graphics are printed using a large format digital image reproduction procedure utilizing a 6-color digital printing process. Images are not silk screened or made with vinyl decals.



## CORNERS, CUT-OUTS CUSTOM PADS

### CORNERS, CUT-OUTS, CUSTOM PADS

We customize pads to fit if your space includes doors, windows, electrical cut-outs, fireboxes, or other odd objects. They can be installed on steel, wood, or concrete surfaces to present a continuous and professional-looking installation.

Stage padding is designed to adhere to the face of your stage easily. It attaches to the top of the stage with a Velcro seal. With our unique beveled hinge design, padding folds nicely over the stage and can be lifted to expose any storage cabinets for removal of equipment when needed.

Our sales staff will assist you with determining the quantity needed to quote and complete your order.



Cut-outs for fencing on gate and door padding

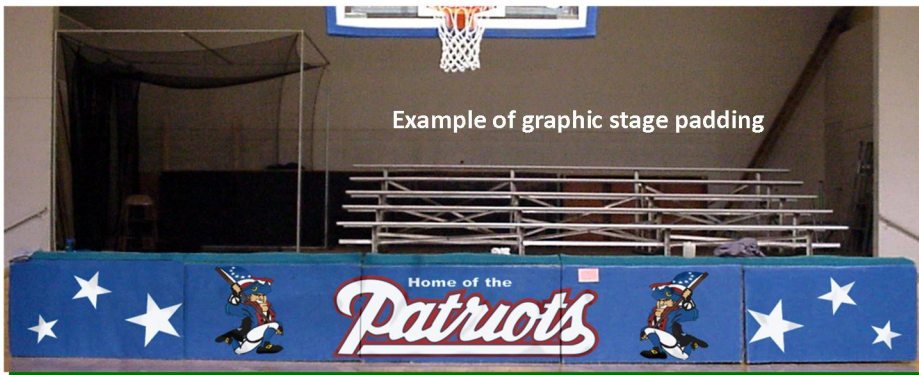

Example of graphic stage padding

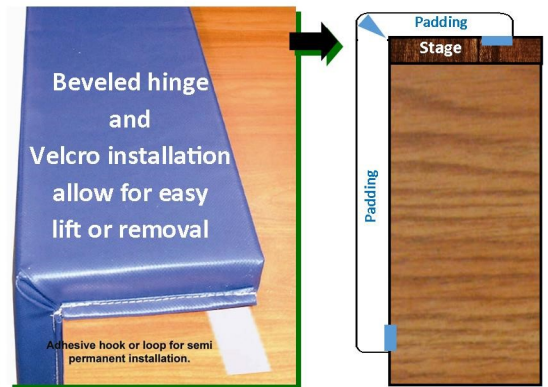

Beveled hinge and Velcro installation allow for easy lift or removal

Adhesive hook or loop for semi permanent installation.



Window Cut-outs



Door and Corner Pads

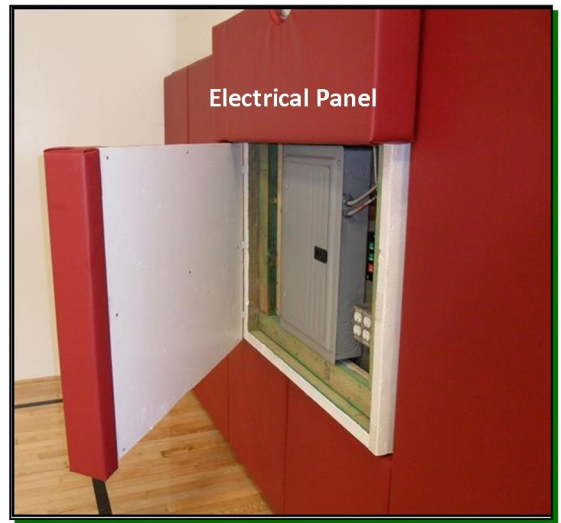

Electrical Panel

### COLUMNS & I-BEAMS

- 3-sided columns, angled/tapered columns, or I-Beams require specially designed solutions to fit.
- Foam filler ranges in thickness and density based on impact specifications.
- Covered in 18 oz. coated vinyl.
- 2 or 3-sided column pads are wood-backed with durable backer board.
- I-beam padding is available with or without wood backing, depending on location and size.

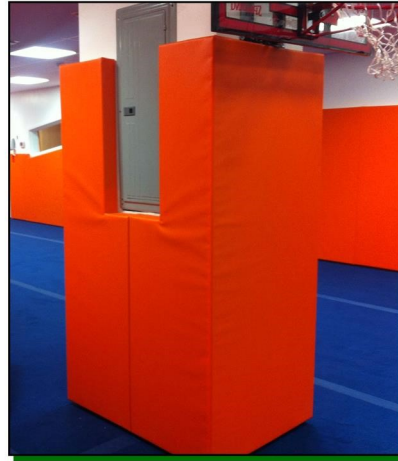

**Custom Padding  
is our Specialty**

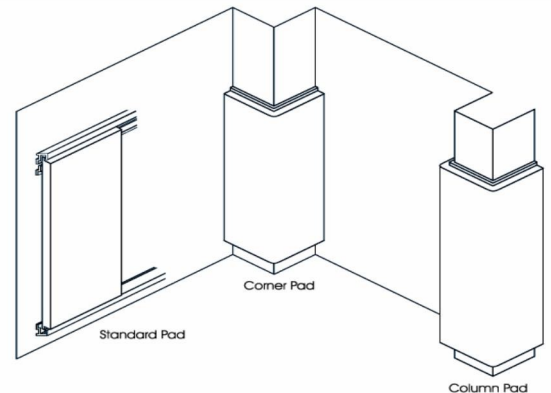

### COLUMN PADS

Column pads that are unique in size and shape are considered custom. We will request dimensions for points listed on the diagrams.

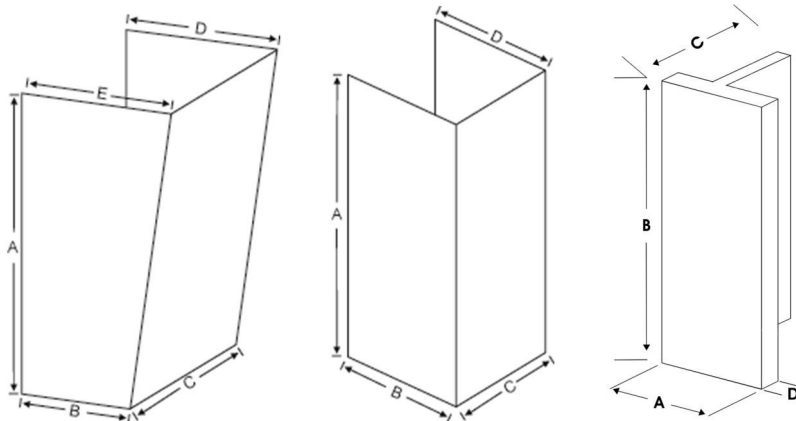

### I-BEAM PADS

I-Beam pads provide protection on steel columns protruding into your usable space. Installation is easy. Pads fit snugly around the face of the beam and are held securely in place with self-adhesive hook and loop fasteners. The standard size of a pad is 8" face (A) and 6' tall (B). Custom sizes can be fabricated to your specifications.



## BACKSTOP PADDING

### FOLDING OUTDOOR BACKSTOP PADDING

Backstop padding provides quick and easy installation and year-round protection.

- Ability to remove in the off-season for storage.
- Cost-effective and affordable.
- Padding is filled with high-density polyurethane and covered with heavyweight coated vinyl.
- Grommet flaps on all four sides for easy attachment to chain link fencing or a solid surface.
- Padding folds every 2-feet.
- Lightweight and easy to store.



## Graphics optional

Feature your team logo with our integrated digital printing, using durable UV inks that are applied directly to your vinyl color.



\*See page 19 for Adhesive Backed Vinyl Repair Kit and Revitalizer Pad Protectant



## OUTDOOR FIELD PADDING

### OUTDOOR FIELD PADDING

Maximum impact protection for outdoor fences, baselines, end zones, fence tops, and sidelines.

- Built to accommodate and fit over exposed areas and odd-shaped objects.
- Durable plywood backer designed for long-term use under all weather conditions.
- UV-protected heavy-weight vinyl available with a 5-year manufacturer's warranty.
- Long-term durability in all weather conditions.
- Multiple secure surface attachment systems to fit any wall, fence, gate, or rail design.
- Designed for tight, smooth, and seamless presentation.
- Ease of recovering.
- Digital printing of logos, advertisements, or user messages is available.

**Durable  
&  
Affordable**



### UNI-RAIL PADDING

Offers great protection. It can be used for dug-outs, baselines, fence top padding, and any facility rails where padding is needed.

- Easy to install and hand-cut in the field to fit the unique features of your railing.
- Available with or without Integrated Digital Printing.
- Grommets evenly spaced for installation with industrial-strength cable ties or rope.
- Easy to remove, replace, or recover at your convenience.
- Available for 1 1/4" to 2 3/4" rails, and custom sizes.



## FENCE & TENNIS WINDSCREEN

**WINDSCREENS** provide shade, block wind, add privacy, ensure security, eliminate distractions, and provide a visual background for players. They can be made to enclose storage cages, batting areas, and tennis courts —or to section off special field areas to provide privacy in commercial or residential areas.



Printable  
80% Shade Factor



Non-printable  
80-90% Shade Factor



**Shade  
and  
UV  
Protection**

### MORE on WINDSCREENS

- Easily attaches to sports fencing with zip ties and/or hog rings.
- Provides 80% or 90% shading.
- UV resistant to block sun damage.
- Great for tennis court enclosures
- Available in green or black woven closed mesh polypropylene or 80% polyester for graphics.
- Graphics can be ordered **with Digital Printing** to promote team logos, facility branding, advertising, or any message/timeline.
- Heavy webbing with reinforced triple stitching and grommets.
- Non-absorbent to protect against water damage.
- High-tensile strength adds to product durability.





**POST PADS** are installed for protection around square or round posts, I-Beams, odd-shaped posts, or other areas of physical contact. These pads are typically used to cover poles or columns in basketball courts, football fields, soccer and baseball fields, playground areas, ski slopes, skate parks, light posts, and areas of indoor & outdoor activity.



### POST PADDING

- Available in 4", 5", and 6" foam thicknesses, and any size diameter.
- Designed to provide correct impact protection.
- 6 ft. standard height - custom heights available.
- Heavy-weight coated vinyl is standard.
- 5-year warranty available - conditions apply.
- **Integrated Digital Printing** on your choice of colored vinyl using our in-house large-format digital printing system.
- Complimentary designs and proofs are provided for your approval.
- Available with 3 closures: Velcro, zipper, or grommet flaps.

### POST PADDING WRAPS

- Designed to wrap around existing post pads.
- Velcro closure for ease of installation and removal for storage.



#### How to Measure for Graphic Wraps (Round Pads Only)

Determine the wrap size by measuring the pad's circumference (not the pole). Wrap a string around the existing pad, then measure the string. We will determine the correct size of the wrap for your order.

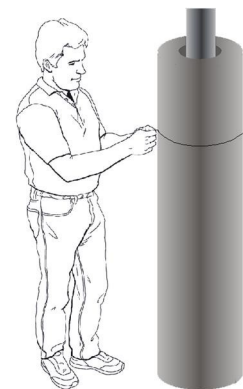



## MIXED MARTIAL ARTS

**MMA PADDING** provides protection in and around boxing cages, as well as elevated and floor-level MMA competition octagons or other sizes and shapes. Add your logo or company name onto corner pads, cage pads, or floors to promote your facility. Padding is easily

mounted with hook and loop attachment. Manufactured to precise dimensions with quality construction. High-impact mats, post pads, and wall pads are also available for training areas.

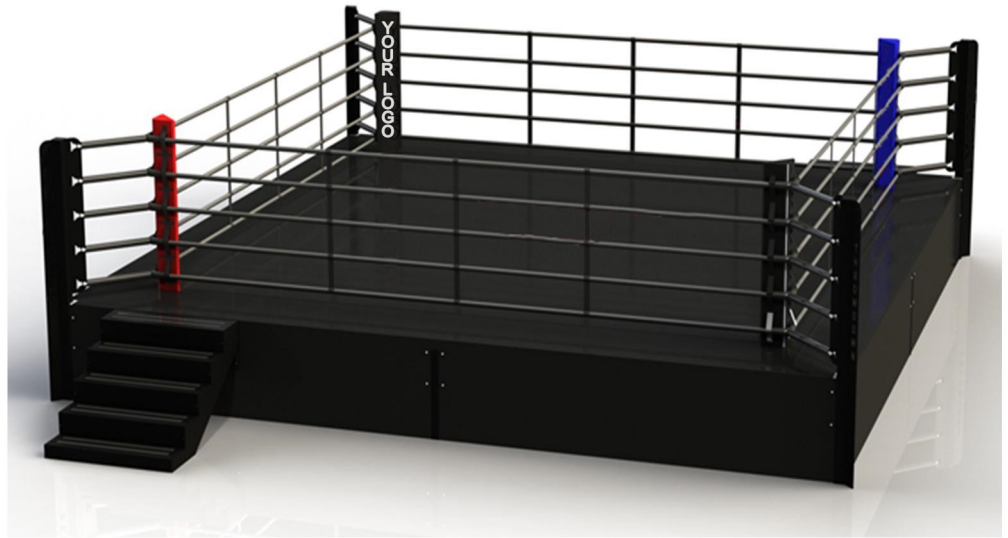

### EXERCISE and FOLDING MATS

Mats for use in fitness, exercise, and work-out environments, as well as for PE programs.

- All mats are available in widths and lengths to meet your needs. Typical sizes are 4' x 6', 4' x 8', 5' x 10' and 6' x 12' in a variety of thicknesses.
- Mats can be ordered in 2 ft. folding panels.
- Several options are available for the density and thickness of interior foam 1" thick up to 2.5" thick, depending on how mats will be used and level of impact.
- Heavy-weight coated vinyl cover.
- **Integrated digital printing** and design available on all mats with messages, logos, exercise programs, or images of your choice. Minimum quantities apply.
- Available with or without handles.
- Available with hook and loop fasteners on 2 or 4 sides to allow mats to be extended.
- Treated with antibacterial and an anti-fungal agent.
- Clean with mild soap and water or our specially formulated mat cleaner. See page 19.
- Made in America. Not an imported product



\*See page 19 for Adhesive Backed Vinyl Repair Kit and Revitalizer Pad Protectant

### LANDING and CLIMBING WALL MATS

Protective landing systems are available for climbing walls, stunts, skill training, slackline padding, and gymnastic skills. Mats come in standard sizes and thicknesses or are custom-made to meet your specific needs for impact protection.

- Density and thickness of interior foam range from 2.5" to 24" thick, depending on how mats will be used, and the level of impact.
- 18 oz. heavy-weight coated vinyl, filled with high-density polyurethane foam.
- Bi-fold, tri-fold, and non-folding options.
- Available with or without reinforced handles.
- Treated with antibacterial and an anti-fungal agent.
- Clean with mild soap and water or our specially formulated mat cleaner.
- **Integrated digital printing** and design available on all mats with messages, logos, exercise programs, or images of your choice. Minimum quantities apply.
- Wall attachment systems and straps are created based on the design of your wall.
- Made in America. Not an imported product.
- *Ships motor freight*

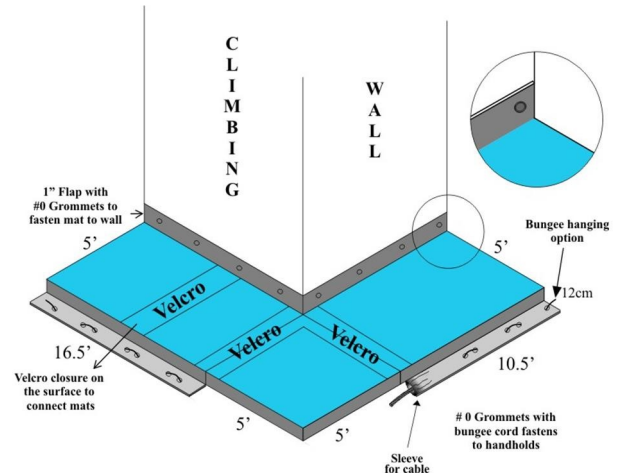
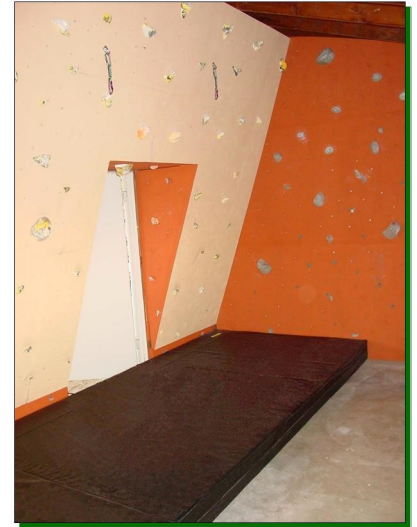

- 4 ¾" Mats meet the ASTM F 1292 recommended performance requirements with a drop height of up to 13 feet.
- 8" Mats meet the ASTM F 1292 recommended performance requirements with a drop height of up to 14 feet.
- Combo mats meet the ASTM F 1292 recommended performance requirements with a drop height of 6 feet.

**SKILL DEVELOPMENT**

This line of training aids and skill shapes are used to develop coordination, increase movement, and improve concentration and technique. These products target issues of timing, balance, strength, and focus. All products are available in a variety of sizes with **integrated digital printing** directly onto colored vinyl in a theme of your choice.



**COMBO BLOCKS** are used for spotting, high bar, uneven bars, or as a vaulting box. Your choice of colors. Includes webbing handles and lightweight foam. Comes in a combination of heights and degrees of firmness. *Ships via motor freight.*



**TUMBLERS** come in a round or octagonal shape with snaps and rings sewn on each end for easy attachment to additional tumblers. Use for vaulting or spotting. Available with interchangeable graphic theme wraps. *Ships via UPS.*

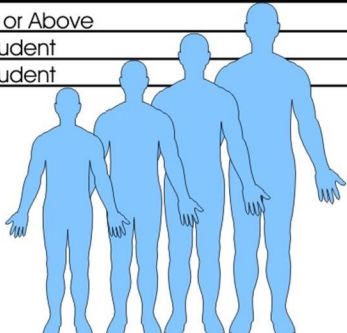

**HANDSPRING TRAINERS** are for tumbling, cheerleading, or gymnastics. Allows for greater repetition with less spotting. Made in age-specific sizes. Available with side-wall graphics. *2-pc. Sections can ship UPS.*

44" Dia = 69" Student or Above	
40" Dia = 61" to 68" Student	
36" Dia = 53" to 60" Student	
32" Dia = 52" Student or Under	
NOTE: The sizes indicated are approximations only and may vary depending on an individual student's ability.	



**LONG JUMP / HOPSCOTCH MAT**

Are great for teaching balance and motor skills. Available with a 4" silk-screened stripe down the middle of one side to simulate a balance beam and a long jump area or hopscotch pattern printed on the opposite side. *Ships via UPS.*

**DONUT HALVES** are an excellent tool for developing balance by rocking. Larger model can be used as a tunnel. Halves connect together with hook and loop fasteners to make a full-size donut. Comes in a set of 2. *Ships via UPS.*

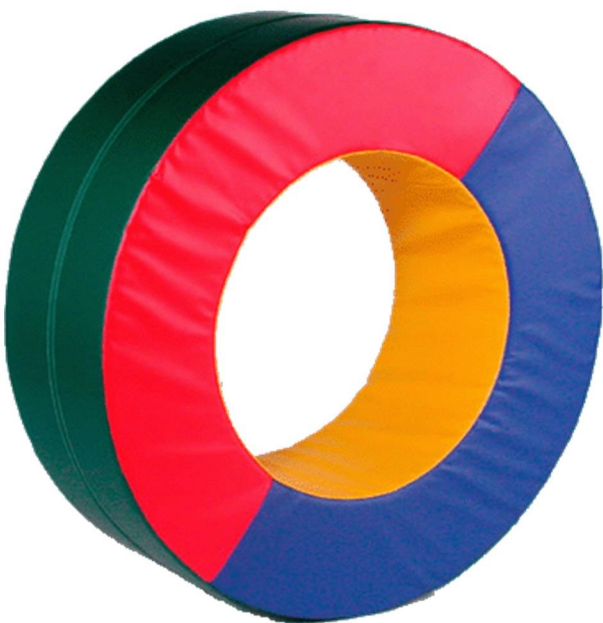

**DONUTS** are for rolling, riding, or stacking. They come in circular or octagon shapes in a variety of sizes. Add balls and make a pit! *Ships via motor freight.*



Downhill



**DOWNHILL** - A tool for teaching basic motor skills. All sizes are available in an assortment of bright rainbow colors or with printed graphics. Available in folding or non-folding style. *Ships via motor freight.*



**MAILBOX** - A large, economical foam padded device designed to help the novice develop



**TRAPEZOID** - A versatile look for teaching jumping skills. Comes in 3 or 4 pieces that are secured using hook and loop fasteners. Available in blue, rainbow, or with graphics. Themed wraps are available to add your club name or produce "winner's stands."  
 4 pc. measures 48" x 48" x 36"  
 3 pc. Measures 36" x 36" x 30"  
*Ships via motor freight.*

Graphic Wraps



Trapezoid (3pc)



Trapezoid (4pc)





**CRAWL & ROLL with BOLSTER**

Used to strengthen crawling and rolling motor skills, or straddle to practice balance skills. It's also fun to roll, crawl through, push, or use for target toss practice.

Size 24" x 22". Bolster 24" x 13".

*Ships via UPS.*

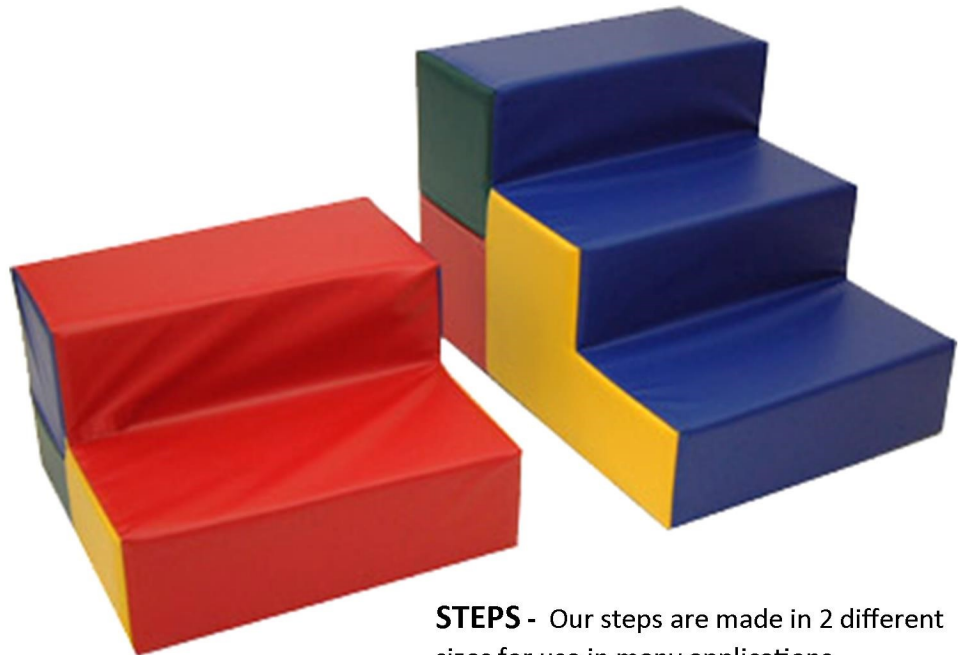

**STEPS** - Our steps are made in 2 different sizes for use in many applications.

Small: 14" x 22" x 24"

Large: 21" x 24" x 33".

*Ships via motor freight.*



**MOLLYBALL** – A popular tool for developing balance, body alertness, and coordination. Designed to withstand the rough and tumble of today's kids, it can also be used for a variety of games.

*Ships via motor freight.*





**BALANCE BEAMS** - Color us crazy, but our beams are a great gross motor skill and balance training aid. The beam is 6' ½" long with a 10" base and a 4" training top.

- Made with vivid graphics in a variety of themes. (ocean, jungle, motor skills, crayons, etc.)
- Filled with crosslink.
- Can hold adult weights.



### ACTIVITY STRIPS

Designed to lay flat on the floor with Velcro hook fasteners that attach to carpeted areas. Printed with gross motor skills, animal moves, or fitness skills. Great for use in a group activity or in between stations. Use our standard designs, or let us help you create ones that fit your individual program. Comes in a set of 6 strips. See our website for more fun themes.



### LEARNING CUBES and PUZZLES

These colorful "Learning Cubes" are great teaching aids. Each block has 6 sides of various activities identifying colors, shapes, numbers, animals, objects, motor skills, actions, emotions, and more. Just toss and play the activity that comes up. Combine 4, 9, or 12 custom pieces to make over-sized puzzles. Made of 18 oz. coated vinyl printed with non-toxic ink and filled with firm foam. Cube measures 8" x 8".



### TUNNELS

Our graphic tunnels are great fun to use in a play area or an obstacle course. The tunnel is also available in infant size. The large tunnel measures 29" x 29" x 36", and the infant tunnel measures 20" x 20" x 24".

### CLIMBERS

Teach cooperative play and develop gross motor skills with themed climbers. Graphics create a new opportunity for teachers to discuss classroom curriculum and plan new activities. Include the tunnel and beams for a fun obstacle course. Climbers are available in 5-piece and 3-piece models and range from infant to large sizes. Activity guides are available with "City" and "Around the World" models. Themes: "Space Station," "Post Office," "Artist," "Ocean," "City Scape," "Farm," "Food Groups," "Jungle Safari," and more!



### RECOGNITION BANNERS

Banners enhance the look of your facility and prominently display achievements. What a great way to showcase your team's accomplishments or recognize sponsors who support your programs. Track each year a league, regional, or state championship was won by using our multi-year kit for additional years. Feature your team mascot, mantra, or team photos. Sponsorship advertising can hang on field fencing, and inspirational messages can be strategically placed around campus. Promote an open house, grand opening, or other special event.

- Complimentary design artwork.
- Available in standard or custom sizes.
- In "Crest" or "Rectangular" shapes.
- 18 oz. coated vinyl.
- Durable and washable with sewn hems.
- Grommets or pole pockets for easy hanging.
- Standard sizes: 3' x 5', 4' x 8', 6' x 10'.
- Reusable year after year.

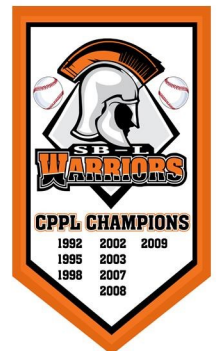
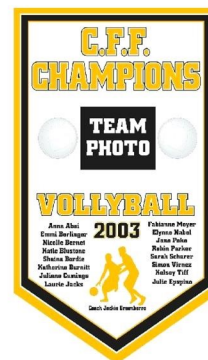

Sponsor Banners

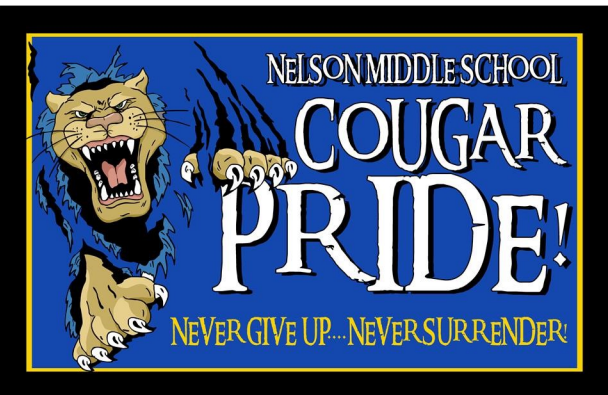

Spirit Banners

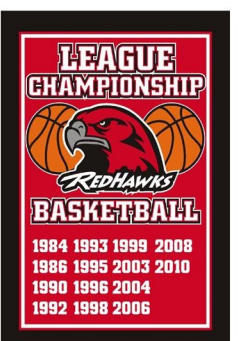
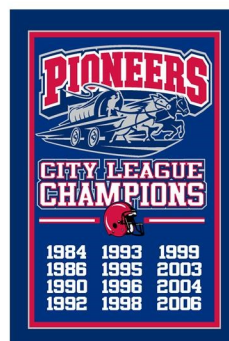

### SVP VINYL REVITALIZER

- Formulated to make your facility look shiny and new for athletic events.
- Revitalizer contains humectants and silicone that protect and replenish moisture on your outdoor vinyl-covered products.
- Revitalizer is a non-corrosive water emulsion product that is non-flammable and non-toxic.
- Pads, mats, and vinyl products should be cleaned prior to applying Revitalizer
- Will not harm digitally printed images on the vinyl; however, it is **not recommended for adhesive-applied decals.**
- Sold 4 gallons per case or individually.



### VINYL CLEANER

- A disinfectant vinyl cleaner solution that can be used on any vinyl pad.
- For use on graphic printed or silk-screened images.
- Will not harm the material or leave a sticky residue.
- Sold per gallon or in concentrate.



### SPORTS PADDING ADHESIVE-BACKED VINYL REPAIR KIT

- An innovative solution to patch tears in your vinyl.
- Will MATCH padding COLOR if ordered through Sports Venue Padding.
- Vinyl is laminated to 3M adhesive backing in the vinyl color ordered from SVP.
- Patches are air-tight and water-tight.
- Sold per roll. (not as shown)
- Length and size based on the type of padding ordered.



## INSTALLATION SERVICES

Several options are available for the installation of sports padding.



- **FIELD MEASURE**  
Prior to our installation, our skilled team will perform a thorough field visit to identify the specific needs of your venue.
- **FACTORY ON-SITE INSTALLATION TEAM**  
We send our factory team to your facility to provide complete turnkey installation services.
- **FACTORY PROJECT MANAGER**  
Our factory project manager travels to your facility and trains your staff to perform the installation.
- **FACTORY INSTRUCTIONS**  
Your staff installs the padding products using factory installation instructions.

Our project team is OSHA 10 and 30-hour compliant to ensure safety on your project.



14135 Artesia Blvd.  
Cerritos, CA 90703

Phone: 562-404-9343 • Fax: 562-404-9335  
Toll Free: 877-599-6855 • Fax: 877-599-9335