

SPORTS VENUE PADDING INC

MULTI-SPORT

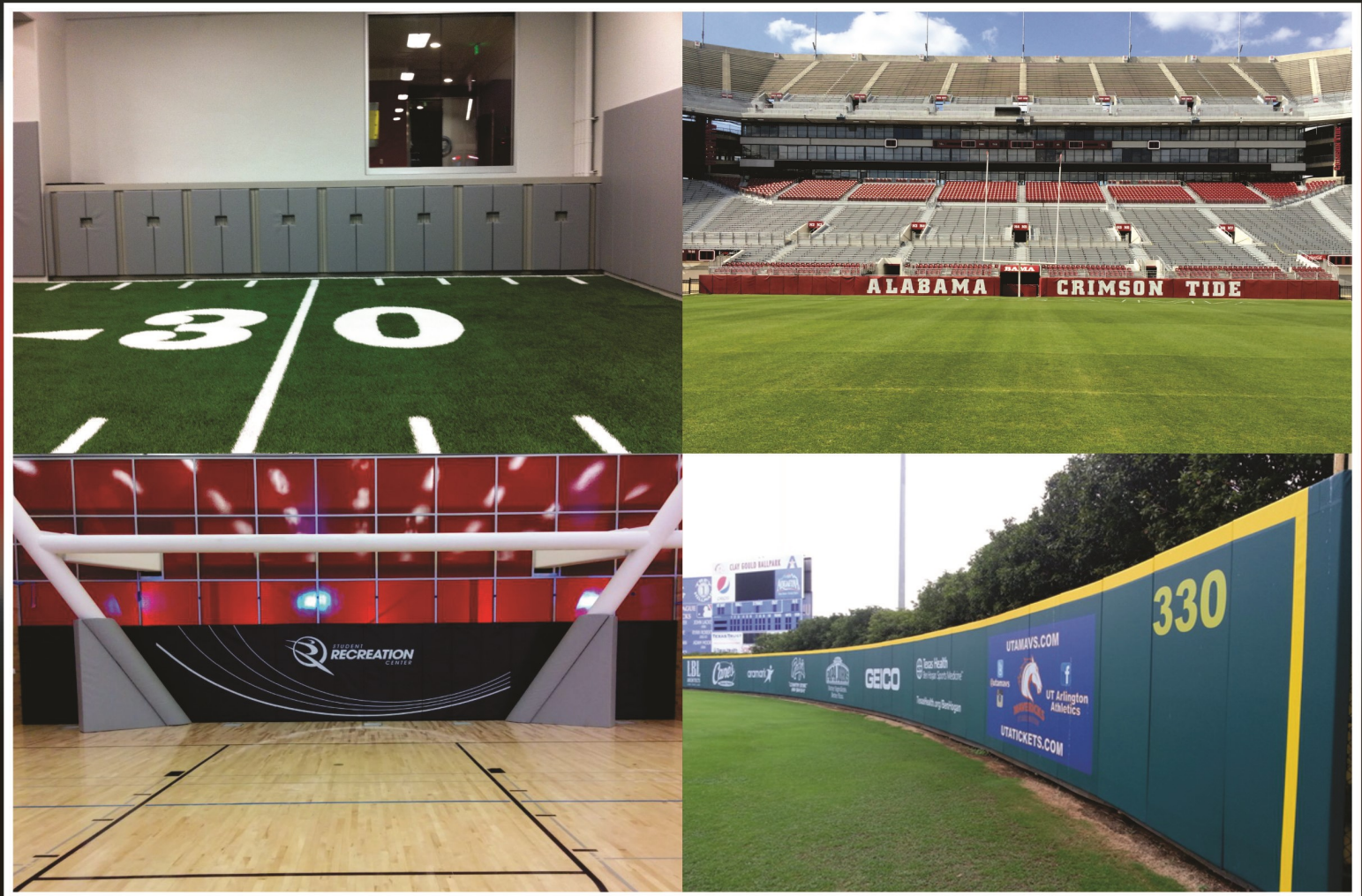

FOOTBALL • BASEBALL • BASKETBALL
INDOOR TRAINING • FITNESS



Sports Venue Padding is a company with over 50 years of experience in the sports protective padding industry. We are not just about sports. We are about player safety, and we never compromise on aesthetics or quality. We offer the industry's broadest range of best-in-class products, which include in-house design, engineering, and factory-trained installation teams, unmatched customer service, and a promise of complete satisfaction.

If you're watching a professional sports game, there's a good chance you're seeing our padding protecting players in high-impact areas throughout indoor and outdoor sports facilities. We fit sports padding to the unique characteristics of facility walls, fences, rails, posts, columns, gates, and other contact areas. Why do customers keep coming back? Because we take on unique construction challenges that our competition won't touch. Just ask any of the professional ball clubs, universities, or municipalities we've worked with.

Our background in the development of innovative padding solutions and team/sponsorship advertising makes us an asset to your team! Integrated digital printing provides a brilliant, oversized, clear image of your logo or sponsor ad that stands out and has extreme durability. None of the chipping or peeling that is common with applied decals.

As a Technical Expert Advisor to ASTM (American Society of Testing Materials), we help define what materials and foam densities best serve an athlete making contact with sports padding while on the move.

Let us show you the Sports Venue Padding difference.



www.SportsVenuePadding.com
P: 562.926.0835 T: 877.599.6855 E: info@svpadding.com



CATALOG CONTENTS

4 - 6	Football
7 - 8	Baseball/Softball
9	Baseline/Bullpen
10 - 11	Rail Padding
12 - 13	Folding Backstop Padding
14 - 15	Sponsor Advertising
16 - 17	Gate Padding
18	Custom Padding
19	Indoor Gymnasium
20	Indoor Training Facility
21	Wall Padding ▪ Corners ▪ Cut-outs
22	Columns ▪ I-Beam Padding
23 - 24	Post ▪ Goal Padding and Wraps
25	Fitness ▪ Climbing Wall Mats
26	Fitness ▪ Wall Mats ▪ Columns
27	Maintenance ▪ Repair Supplies
28	Installation Services

Stadium Field Padding

Impact protective padding from the End Zones to Side Lines to the Goal Posts.

Several options available;

- Available in 3", 4", 5" and 6" thickness to support the amount of protection required based on field design * 3" is current standard
- Foam filler densities specifically designed to ensure correct deceleration upon impact based on projected speed prior to impact
- UV protected heavy weight vinyl cover designed to provide protection from fading and early wear. Comes with a 5 year manufacturer's warranty
- Vinyl is optimized for state of the art digital printing of logos
- Sealed 3/4" thick plywood designed for long term durability under all weather conditions, environmentally conscious materials
- Multiple secure surface attachment systems to fit any wall, fence or column/post design
- Field padding is designed to incorporate **"One Piece Construction"** wherever possible to promote a seamless appearance, greater **"Live Area for Digital Printing"** and to allow for ease of recovering when updating graphics or advertising

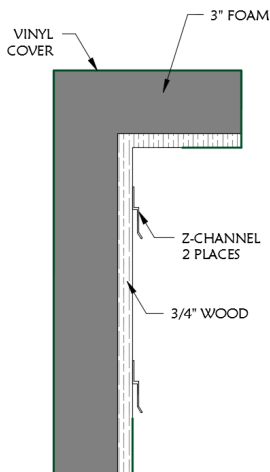

- One piece construction
- Easy to recover as needed

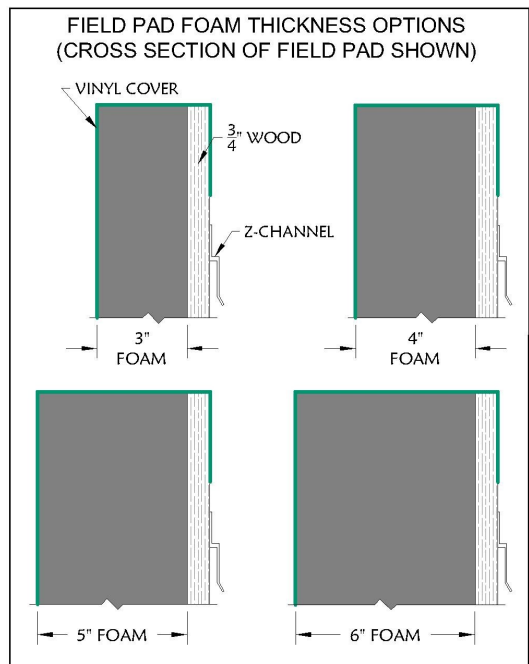

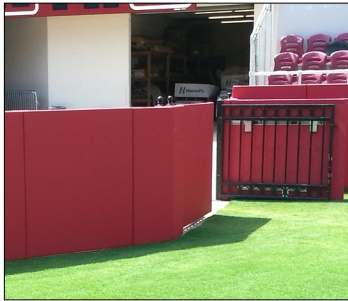
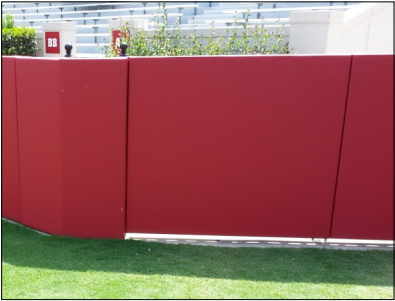

Stadium Gate Padding

- Innovative sliding gate padding that opens easily with 90° full range of motion
- A seamless look with all padding installed at the same height.
- No exposed hinges
- Gate slides are encased in heavy duty outdoor brackets developed specifically for commercial gate systems



Goal Post Padding

- Goal post padding can be made at any height
- Foam filler density designed for high impact protection and is available in 4", 5" or 6" thickness
- Durable heavy weight vinyl cover comes with a five-year manufacturer's outdoor warranty
- Available with Velcro closure, zipper closure or grommet closure with lacing
- Post padding made in round, square or rectangular shapes



Football Indoor Training Facility

- Indoor padding to custom fit the unique characteristics of your facility walls
- Cut-outs for outlets, fire extinguishers, thermostats, 2- and 3-sided columns, drinking fountains, around indoor bleachers and any other wall features in facility
- Foam fillers range from 1 3/8" - 3" and are available to meet fire standard E84, NFPA 101-255 Life Safety Code
- Heavy weight coated vinyl cover
- Several attachment installation options are available

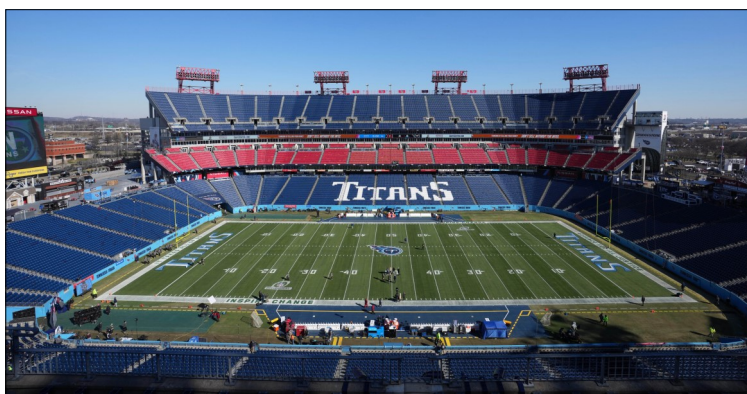

***See page 27 for Adhesive Backed Vinyl Repair Kit and Revitalizer Pad Protectant**



Padded Team Field Signs

The process of applying *Integrated Digital Printing* of logos or sponsor advertising is different from anything you have experienced before. No decals or paint to chip, peel or tear during the season

- Durable UV inks are applied directly to your vinyl color to create a beautiful billboard on field sidelines
- Logo/Ad banners are attached to front and/or back with Velcro on 4 sides and can be changed anytime
- Complimentary graphic layout for your approval of artwork and field position



Windscreen

- Easily attaches to sports fencing and attaches with zip ties and/or hog rings
- Provides shade, blocks wind, adds security and visual background for players
- Can enclose fenced storage area
- Available in woven closed mesh Polypropylene in either black or green, 80% or 90% shading
- Available in an 80% shade polyester vinyl coated mesh and *can be ordered with Digital Printing* to promote team logos, division league designation or a message/timeline you want to feature
- Non-absorbent to protect against water damage
- High Tensile strength adds to product durability
- UV resistant to block sun damage



Stadium Field Padding

Impact protective padding for outfield/baseline walls and bullpens. Several options are available:

- Available in 3", 4", 5" and 6" thickness to support the amount of protection required based on field design
- Foam filler densities specifically designed to ensure correct deceleration upon impact based on projected speed prior to impact
- UV protected heavy weight vinyl cover designed to provide protection from fading and early wear. Comes with a 5 year manufacturer's warranty
- Vinyl is optimized for state of the art digital printing of logos
- Sealed 3/4" thick plywood designed for long term durability under all weather conditions, environmentally conscious materials
- Multiple secure surface attachment systems to fit any wall or fence design

Field padding is designed to incorporate **"One Piece Construction"** wherever possible to promote a seamless appearance, greater **"Live Area for Digital Printing"** and to allow for ease of recovering when updating graphics or advertising.

***See page 27 for Adhesive Backed Vinyl Repair Kit and Revitalizer Pad Protectant**



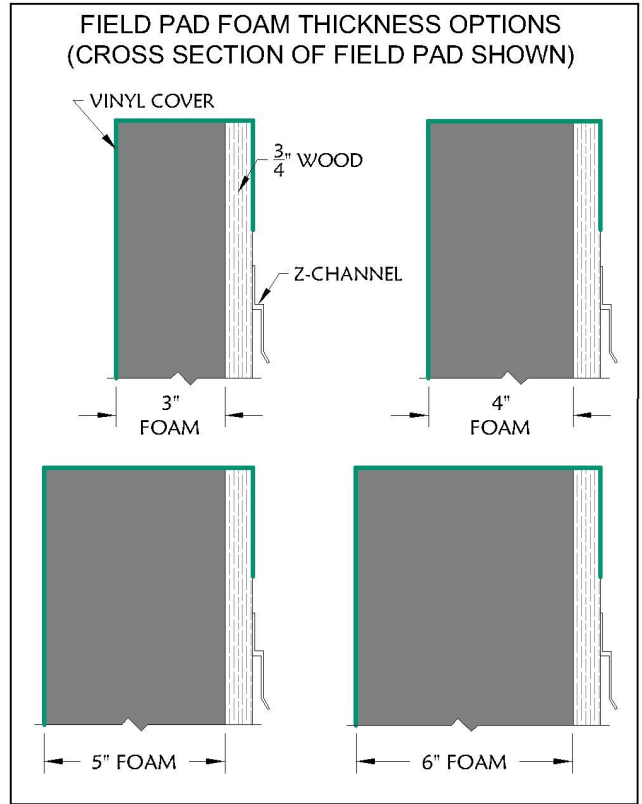

Baseline/Bullpen Padding

Baselines vary in height and typically have objects along the way that require specialized padding to cover. Bullpens typically incorporate both vertical and horizontal padding.

Our padding is built to accommodate and fit over all exposed areas for maximum protection.

- Available in 3", 4", 5" and 6" thickness to support the amount of protection required based on field design * 3" is current standard
- Foam filler densities specifically designed to ensure correct deceleration upon impact based on projected speed prior to impact
- UV protected heavy weight vinyl cover designed to provide protection from fading and early wear. Comes with a 5 year manufacturer's warranty
- Vinyl is optimized for state of the art digital printing of logos and sponsor advertising
- Sealed 3/4" thick plywood designed for long term durability under all weather conditions. Environmentally conscious materials
- Multiple secure surface attachment systems to fit any wall or fence design
- Baseline/Bullpen padding is designed to incorporate **"One Piece Construction"** wherever possible to promote a seamless appearance, greater **"Live Area for Digital Printing"** and to allow for ease of recovering.

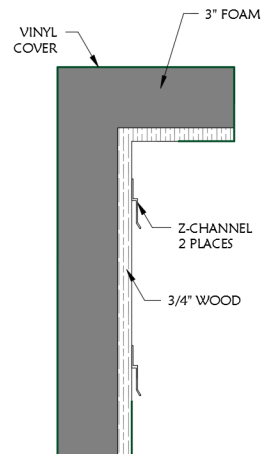
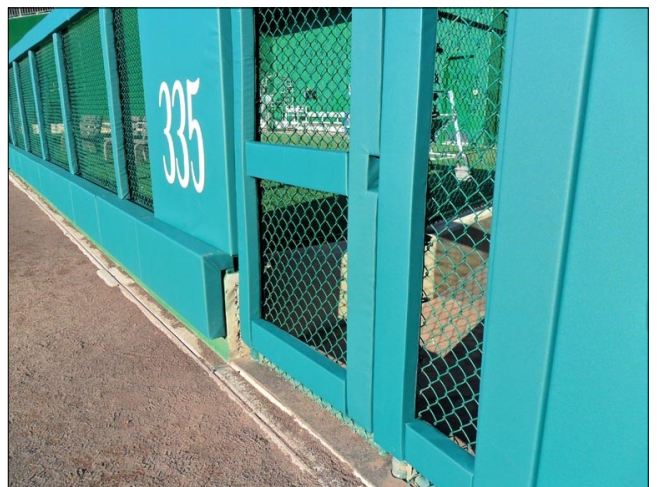

- One piece construction
- Easy to recover as needed

Uni-Rail Padding

Offers great protection for the players. Can be used for dug-outs, baselines and fence top padding.

- Easy to install, closed cell polyethylene high impact foam can be hand cut in the field to fit the unique features of your railing
- Seamless vinyl top cover is available with or without Integrated Digital Printing and is installed over the foam. Cover comes with grommets evenly spaced for installation with industrial strength cable ties or rope
- Easy to remove and replace at your convenience
- Beautiful seamless presentation is both smooth and tight
- Durable and affordable
- Available for 1 1/4" to 2 3/4" rails

For other rail sizes., please ask us about other additional options

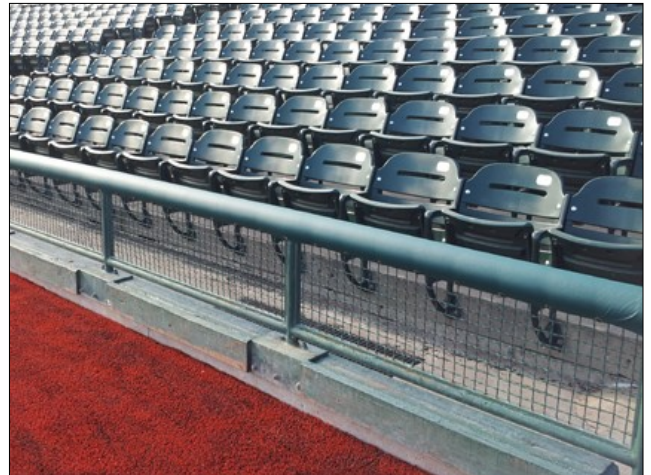



PERMA-RAIL PADDING

Perma-Rail Padding (Patent Pending)

The most innovative development in *Dug-Out Rail Padding* is now available! This advancement includes the following unique advantages

- Aluminum understructure designed to be a permanent fixture in your dug-out
- Features a solid locking system to prevent rotation when leaned on by players
- Closed cell polyethylene high impact padding protection will not absorb water or sag over time
- Solid seamless top cover features large 6" front face for team logo and/or sponsor advertising. Cover can be replaced as often as you like. Easy to remove and re-install a new cover
- Fits 1.5" to 3" dug-out rail

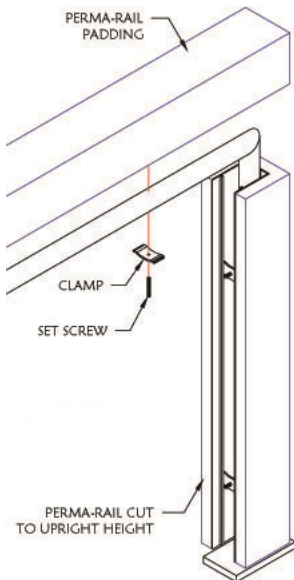
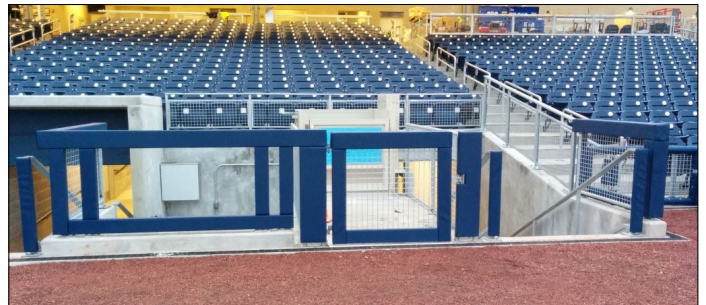
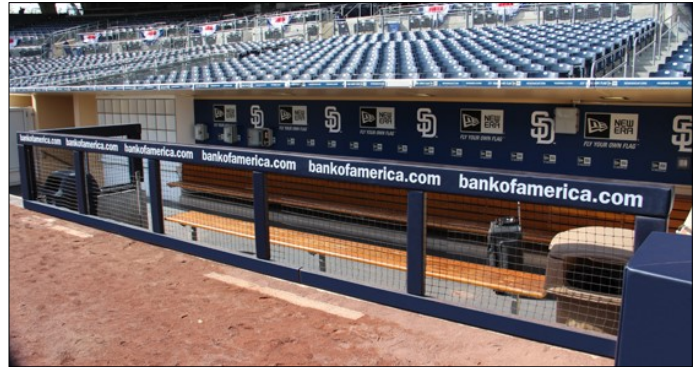

PATENT PENDING



www.SportsVenuePadding.com

P: 562.926.0835 T: 877.599.6855 E: info@svpadding.com



FOLDING BACKSTOP PADDING

Folding Backstop Padding

Folding backstop padding offers quick installation and ability to remove in the off season for storage

- A cost-effective solution to padding backstops
- Padding is filled with high density polyurethane and covered with heavy weight coated vinyl
- Grommets flaps on all 4 sides for attachment to chain link fencing or solid surface
- Padding folds every two feet, making it lightweight and easy to store
- Feature your team logo with our integrated digital printing using durable UV inks that are applied directly to your vinyl color



***See page 27 for Adhesive Backed Vinyl Repair Kit and Revitalizer Pad Protectant**

www.SportsVenuePadding.com

P: 562.926.0835 T: 877.599.6855 E: info@svpadding.com

Wood-backed Backstop Padding

Feature your team logo with our integrated digital printing using durable UV inks that are applied directly to your vinyl color

- Several mounting options: masonry, concrete, wood backstop, or chain-link
- Padding is filled with high density polyurethane
- UV protected heavy-weight vinyl available with 5-year manufacturer's warranty
- Available in 3", 4", 5" and 6" thickness to support the amount of protection required based on field design.
- Foam filler densities specifically designed to ensure correct deceleration upon impact based on projected speed prior to impact
- Environmentally conscious materials



Sponsor Advertising

The process of applying Integrated Digital Printing of logos or sponsor advertising is different from anything you have experienced before. No decals or paint to chip, peel or tear during the season.

- Durable UV Inks are applied directly to your vinyl color to create a beautiful billboard on field walls or rails
- Pads can be re-wrapped if graphics need to be changed or updated
- Complimentary graphic layout for your approval of artwork and field position

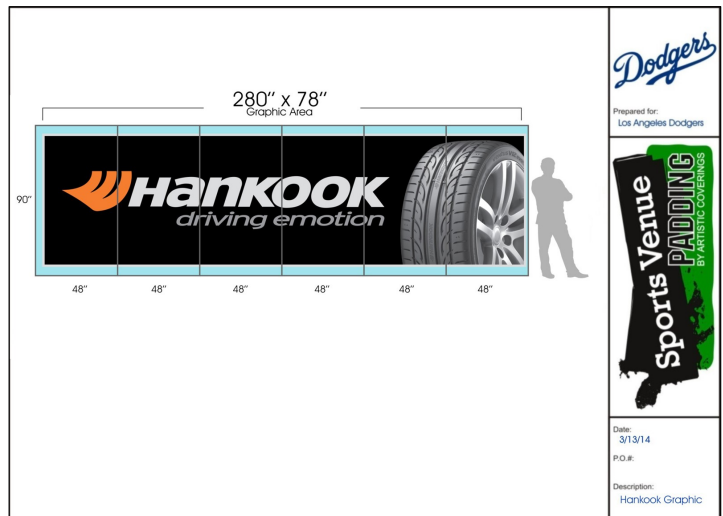
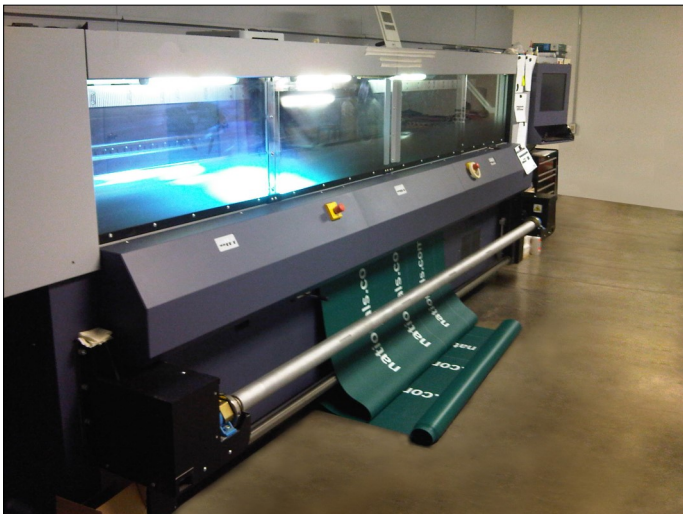

Here's how simple the process can be for you...

- **Step 1** - A complete field lay-out created for your approval by our in-house art/design team displaying all your team/sponsor signage
- **Step 2** - An individual lay-out of team/sponsor signage with dimensions created for your approval by our in-house art/design team prior to production
- **Step 3** - Production of new wall pads or replacement vinyl covers with the approved signage for installation as per the completed field lay-out

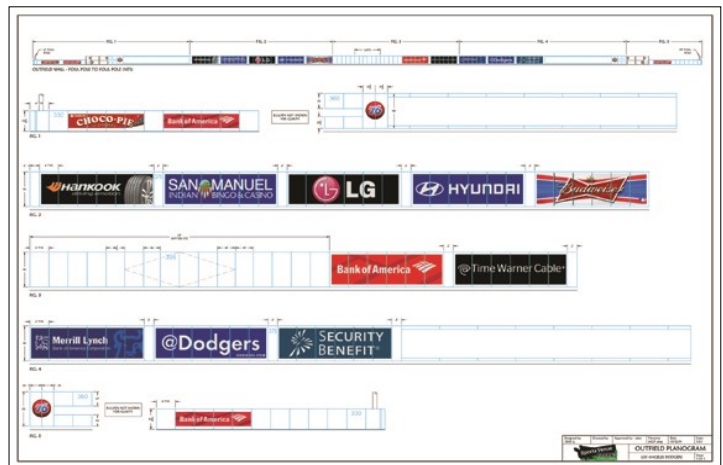



SPONSOR ADVERTISING



NOTES:	Color (PMS, RGB, CMYK)	Location	Date
	Background 16,100,100,0	Outfield ft	
	Artwork 15% grey	Approval req'd by	Install Date
	Vinyl SD Blue	Sponsor	Filename SDTOYS14

Prepared for:
New York Mets
Revised

Date: 1/17/14
P.O.#:
Description: Stub Hub graphic

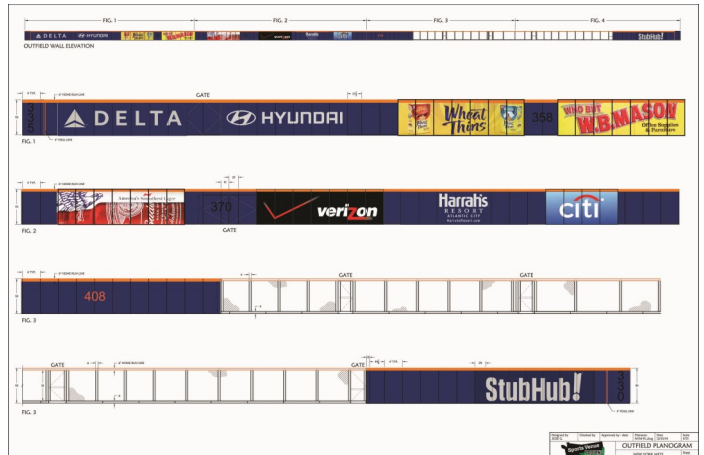
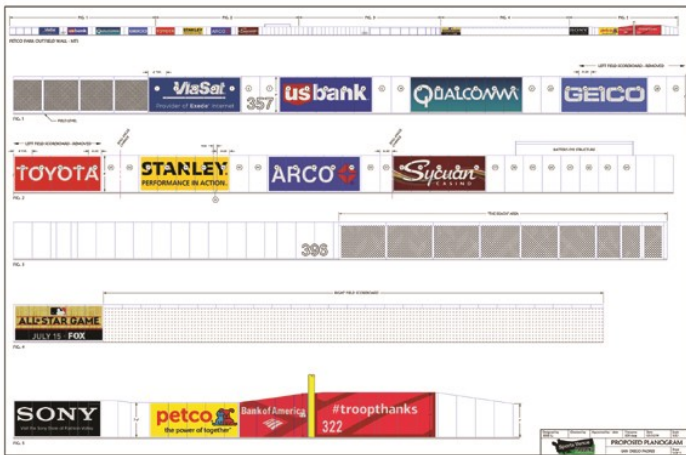

Sliding Gate Pad

A creative field level solution to conceal hinges on any wall with gates, that swing into the field of play.

- Great for installation on baseline, sideline or short walls where you normally see a break in the wall padding exposing the hinges
- Provides seamless look so gate locations are all the same height as aligning pads and all hinges are covered
- Slides glide easily to allow full range of motion for a full 90° opening
- Designed for all gates that swing into field of play
- Provides uninterrupted appearance and can include integrated digital printing. You can easily put graphics across the hinge area
- Specially designed commercial slides for all weather conditions





WEDGE GATE PADDING

Automatic Wedge Field Gate Pad (Patent Pending)

Sports Venue Padding now offers a gate pad that provides safety, convenience, and the ability to present continuous graphics in all gated areas of your stadium.

- Available in any size with or without graphics
- Designed for all gates that swing into the field of play
- Wedge pad covers and protects exposed hinges that can cause injury to the players
- Automatic hinged feature eliminates the need to manually remove vinyl cover or sewn wedge pads, attached with Velcro
- Hinged pad returns to closed position automatically when gate is closed
- Provides seamless appearance and can include integrated digital printing. You can easily put graphics across the hinge area



**A PATENTED SOLUTION
OFFERED BY
SPORTS VENUE PADDING**



www.SportsVenuePadding.com

P: 562.926.0835 T: 877.599.6855 E: info@svpadding.com

Custom Padding

Every facility has areas that require special padding to cover doors, gates, electrical boxes, camera wells, concrete curbs, vertical posts, special seating areas and more.

- Field wall and surface irregularities require the development of special padded boxes, L-Shaped padding, round shaped padding or cut-outs to cover exposed areas.
- Replacement seat padding built to fit your specific seat design
- Seat Back Slip Covers to promote team logo or sponsor advertising
- Sectional Weather Protection Covers to protect your seats during harsh weather conditions
- Mesh section covers to close off unused areas allowing them to become great advertising vehicles
- Bench padding for dug-outs
- Plate, mound or turf covers
- Batter's eye windscreen
- Scoreboard top padding

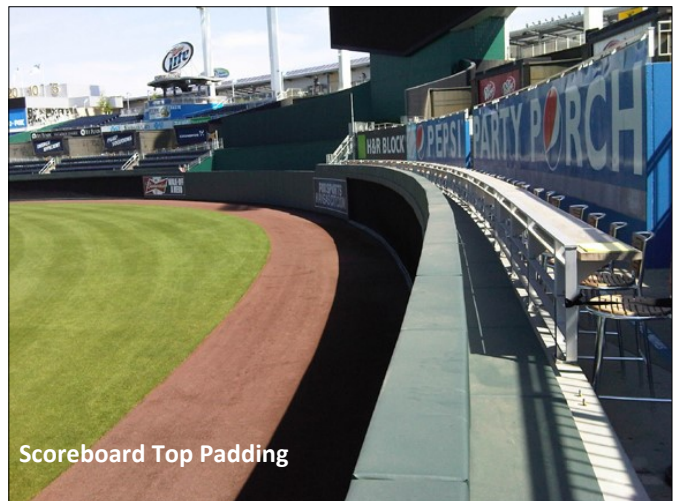

Wall Padding

- Indoor wall padding is available in any height and is produced in 2' wide panels
- Many filler densities, thickness and combinations are available to meet all safety requirements
- Covers are made with an 18oz coated vinyl
- Durable backer board for attachment to walls
- Cut-outs for outlets, fire extinguishers, thermostats, 2 and 3 sided columns, drinking fountains, around indoor bleachers and any other wall features in your facility
- Wall padding options include meeting E84-NFP 101/255 fire-lifestyle safety regulations
- Can be **digitally printed with our integrated print system** with team logo's, sponsor advertising or special messages
- Complimentary design layouts let you choose the look you want



Indoor Gymnasium/Training Facility Padding

- Indoor wall padding is available in any height and is produced in 2' wide panels
- Many filler densities, thickness and combinations are available to meet all safety requirements
- Covers are made with an 18oz coated vinyl
- Durable backer board for attachment to walls
- Cut-outs for outlets, fire extinguishers, thermostats, 2 and 3 sided columns, drinking fountains, around indoor bleachers and any other wall features in your facility
- Certi-Flame wall padding option meets E84-NFPA 101/255 fire-lifestyle safety regulations.



Fire Resistant

- Can be **digitally printed with our integrated print system** with team logo's, sponsor advertising or special messages
- Complimentary design layouts let you choose the look you want

Wall Padding Mounting Options

Unless otherwise specified by customer, all standard wall pads are made with 1" lip top and bottom). Here are additional mounting options:

- 1" lip top and bottom— industry standard—installed directly onto the wall using appropriate bolts
- Aluminum wall channel top and bottom, 3-piece framing system—best for the ability to replace individual pads
- Z-Channel top and bottom (no lips) is best for wall to wall installations
- Z-Channel top and 1" lip bottom—the best aesthetic look with pads secured to the wall on the bottom allowing no side to side movement for installations that are not wall to wall

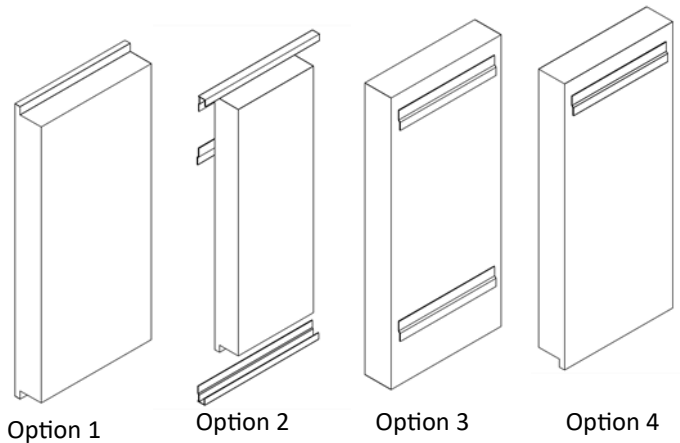

Wall Padding Corners & Cut-outs

- Cut-outs come in any size or shape to allow access to all wall features that cannot be covered up
- Corner pads can wrap a corner and columns along the wall space



Columns and I-Beam Padding

- Based on your indoor walls 3 sided columns, angled/tapered columns or I-Beams require specially designed solutions to fit
- This is our specialty
- Foam filler ranges in thickness and density based on closeness of probable impact by players
- Covered in heavy weight coated vinyl
- 2 or 3 sided column pads are wood backed with durable backer board
- I-Beam padding is available with or without wood backing depending on location and size



Column Pads

Column pads that are unique in size and shape are considered custom. Please provide dimensions for points listed on diagram.

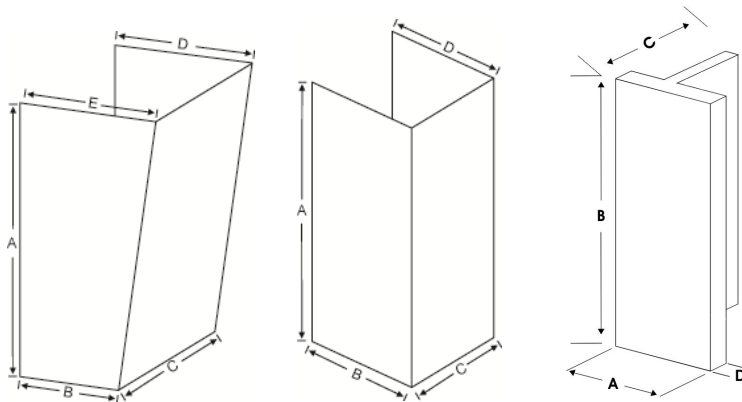

I-Beam Pads

I-Beam pads can provide protection on steel columns protruding into your usable space. Installation is easy, pads fits snugly around the face of the beam and is held securely in place with self adhesive hook and loop fasteners. Standard size of pad is 8" face (A) and 6' tall (B). Custom sizes can be fabricated to your specifications.

Post/Goal Padding and Wraps

- Available in 4", 5" and 6" thicknesses
- Standard height is 6', pads are available at any height
- Foam filler density specifically designed to provide the correct impact protection
- Covered in heavy weight coated vinyl
- Vinyl is optimized for state of the art *integrated digital printing* of school logos
- Complimentary designs provided for your approval
- Three types of closures are available - Velcro, Zipper and Grommet Flaps

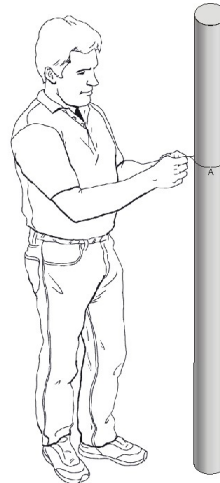

Measuring Guide

Determine the size of your post by measuring the circumference. Using a piece of string, wrap it around the post and measure the string. We will convert the size for you.

Post Padding Wraps

- **Integrated Digital Printing** in your color vinyl on our large format digital printing system
- Designed to wrap around existing post padding that can be removed to store after a game
- Heavy weight coated vinyl are standard, also available in 5 year warranty heavy weight vinyl
- Velcro closure for ease of install and removal
- Measure circumference by wrapping a string around your existing pads, please provide height too

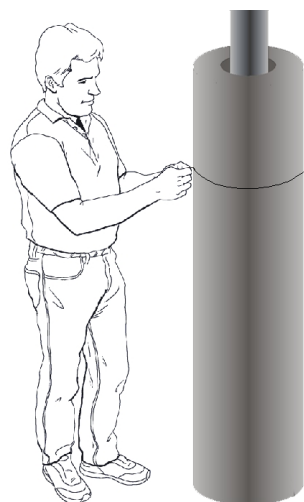

How to Measure for Graphic Wraps

Post pad wraps are measured the same way as post pads. See page 24.



Fitness/Exercise Mats

- All Mats are available in widths and lengths to meet your needs. Typical sizes are 2'x6', 4'x8', 5'x10' and 6'x12'
- Mats can be ordered folding or non-folding
- Several options are available for density and thickness of interior foam 1" thick up to 24" thick depending on how mats will be used
- Heavy weight coated vinyl cover
- Vinyl is optimized for state of the art **integrated digital printing**
- All mat products can be digitally printed with messages, logos, exercise programs or images of your choice. Minimum quantities apply
- Made in America. Not an imported product



Bouldering/Climbing Wall Mats

- Mats are made to fit the design of your wall or to cover the entire length of your wall
- Mats can be ordered folding or non-folding
- Several options are available for density and thickness of interior foam
- Heavy weight coated vinyl cover. Vinyl is optimized for state of the art **integrated digital printing**
- Wall attachment systems are created based on the design of your wall

- 4 ¾" Mats meets the ASTM F 1292 recommended performance requirements with a drop height of up to 13 feet.
- 8" Mats meets the ASTM F 1292 recommended performance requirements with a drop height of up to 14 feet.
- Combo mats meets the ASTM F 1292 recommended performance requirements with a drop height of 6 feet.

Examples of custom hanging options available for additional cost

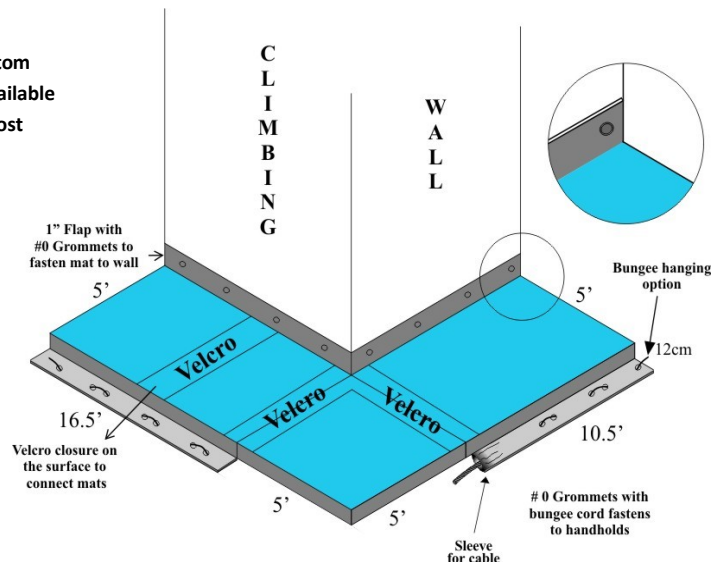
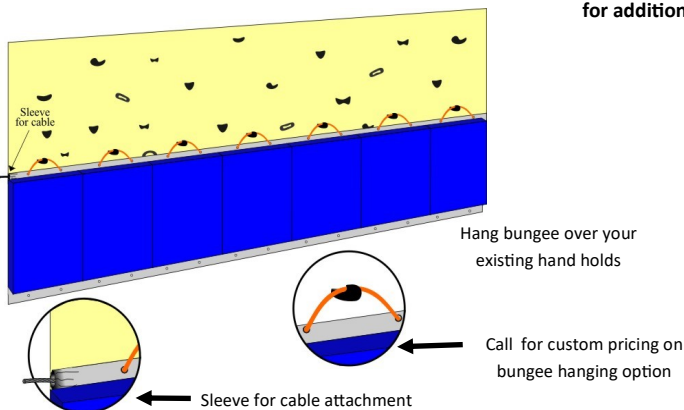

Wall Padding

- Indoor wall padding is available in any height and is produced in 2' wide panels
- Many filler densities, thickness and combinations are available to meet all safety requirements
- Covers are made with an 18oz coated vinyl
- Durable backer board for attachment to walls
- Cut-outs for outlets, fire extinguishers, thermostats, 2 and 3 sided columns, drinking fountains, around indoor bleachers and any other wall features in your facility
- Wall padding options include meeting E84-NFP 101/255 fire-lifestyle safety regulations
- Can be **digitally printed with our integrated print system** with team logo's, sponsor advertising or special messages
- Complimentary design layouts let you choose the look you want



Column Padding

- Based on your indoor walls 3 sided columns, angled/tapered columns or I beams require specially designed solutions to fit
- This is our specialty
- Foam filler ranges in thickness and density based on closeness of probable impact by players
- Covered in heavy weight coated vinyl
- 2 or 3 sided column pads are wood backed with durable backer board



SVP Vinyl Revitalizer

- Formulated to make your facility look new and shiny for athletic events
- Revitalizer contains humectants and silicone that protects and replenishes moisture on your outdoor vinyl covered products
- Product is non-flammable, non-toxic, and is a non-corrosive water emulsion product
- Padding should be cleaned prior to applying Revitalizer
- Will not harm digitally printed images on the vinyl, **not recommended for adhesive applied decals**
- Sold in 4 gallon case



Vinyl Cleaner

- A disinfectant vinyl cleaning solution that can be used on any vinyl pad
- Can be used on graphic printed or silk screened images
- Will not harm material or leave a sticky residue
- Sold per gallon or in concentrate



Sports Padding Adhesive Backed Vinyl Repair Kit

*****Matches Your Pad Color*****

- An innovative solution to patch tears in your vinyl
- Will **Match** padding color ordered through Sports Venue Padding
- Vinyl is laminated to 3M adhesive backing in the color ordered from SVP
- Patches are air tight and water tight
- Sold per roll. Length and size based on type of padding ordered





Installation Services

Several options are available for the installation of sports padding:

- **Field Measure** - Prior to the installation, our skilled team will perform a thorough field visit to identify the specific needs of our field.
- **Factory On-site Installation Team** - We send our factory trained team to your facility for a complete turnkey installation.
- **Factory Project Manager** - Our factory project manager travels to your facility and trains your staff to perform the installation.
- **Factory Instructions** - Your staff installs padding produces using factory installation instructions.

OSHA 10 & 30 Hour compliant project management for your project.



Sports Venue Padding
Toll Free: 877.599.6855 Fax:877.599.9335
www.sportsvenuepadding.com
P: 562.926.0835 E: info@svpadding.com